

構成内容 / Components				
No.	名称 / Part name	数量 / Pcs	材質 / Material	色・表面処理 / Color・Finish
1	上下カバー Top and Bottom cover	各1 1 each	アクリル板 t2.0 Acrylic t2.0	透明 Transparent
2	Wパネル W panel	2	アクリル板 t2.0 Acrylic t2.0	透明 Transparent
3	Dパネル D panel	2	アクリル板 t2.0 Acrylic t2.0	透明 Transparent
4	支柱 Extruded pillar	4	アルミ押出材 A6063S-T5 Extruded aluminium A6063S-T5	シルバーアルマイト Silver・Anodized
5	取付ビス (六角穴付皿M3 x 8) Screw (Hexagonal M3 - 8)	8	ステンレス Stainless steel	無処理 Unfinished
6	ゴム足 / Rubber feet	0 or 5	ポリウレタン / Polyurethane	透明 / Transparent

■六角レンチ付です。  
Hexagonal wrench included.

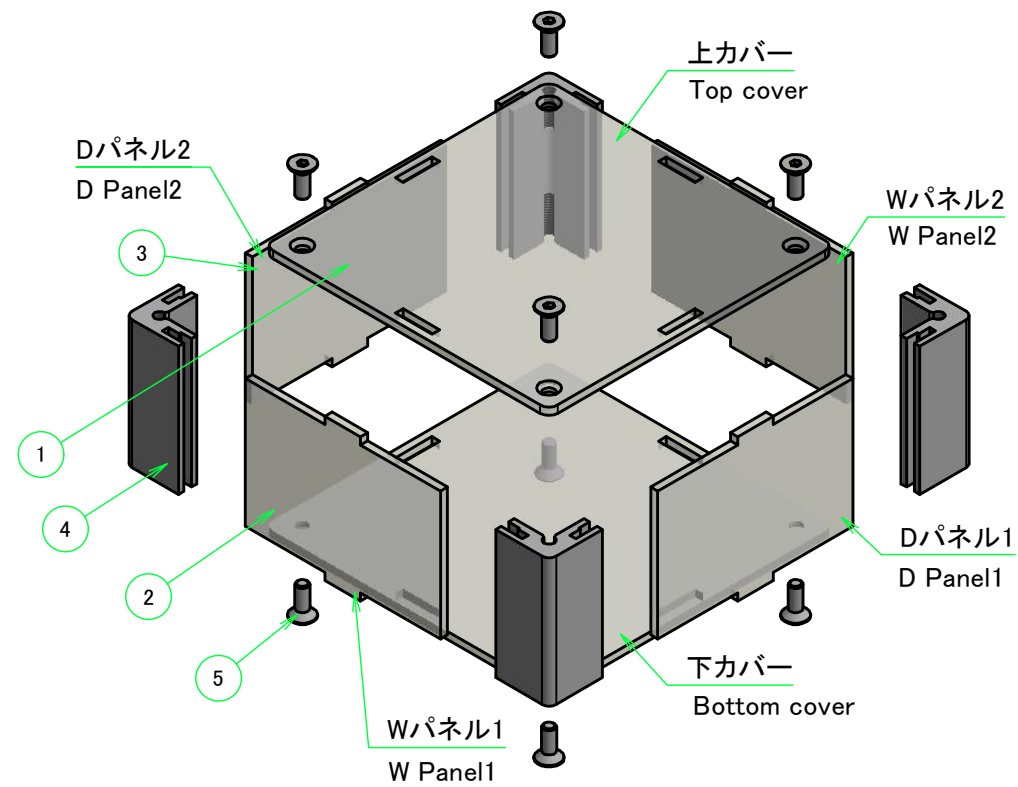

ケース型番 / Product Number

SKSF  -  -  K15

W H D タイプ Type ゴム足 Rubber feet

\*ゴム足は任意の位置に貼り付けできます。  
\*Adhesive rubber feet in cluded

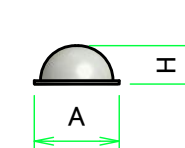

ゴム足 / Rubber feet		
記号 / Code	A	H
N (無し) / None	-	-
S	11.2	5.1
L	15.7	7.9

W・H・D 寸法制限範囲 / Dimension limit range		
W	H	D
101 ~ 150	30 ~ 500	50 ~ 100

株式会社タカチ電機工業 TAKACHI ELECTRONICS ENCLOSURE CO., LTD.			品名/Title 角型スケルトンフリーサイズケース CUSTOM SIZED ACRYLIC CASE	尺度/Scale
承認/Approved	検図/Checked	製図/Created	型番/Product number SKSF□-□-□K15□ (W101~150, D50~100)	
中根	野村	常山	作成日/Date 2020/11/20	1 / 5

外視 / External View

Wパネル2 / W Panel 2

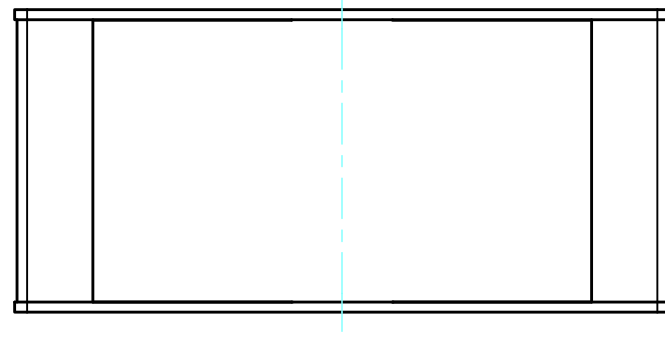

Dパネル2 / D Panel 2

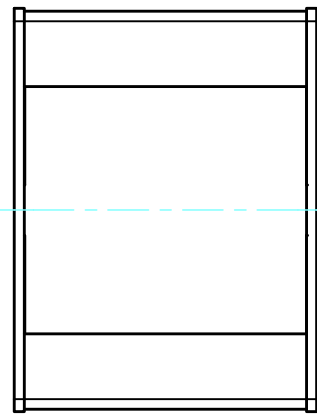

上カバー / Top cover

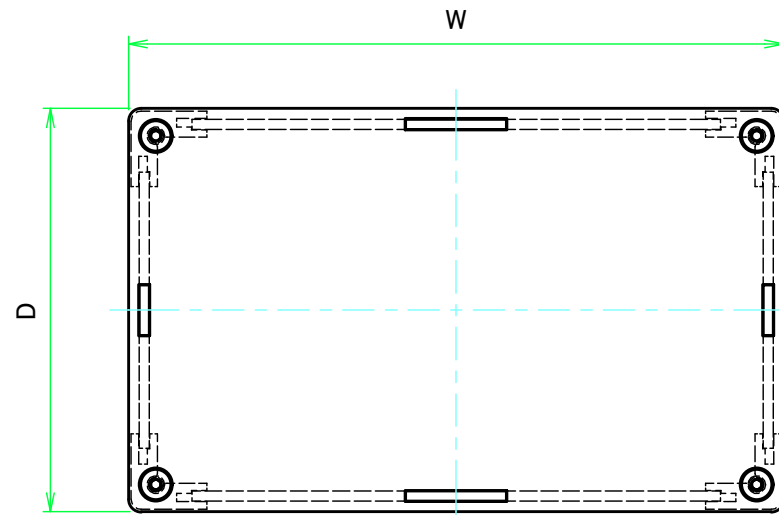

Dパネル1 / D Panel 1

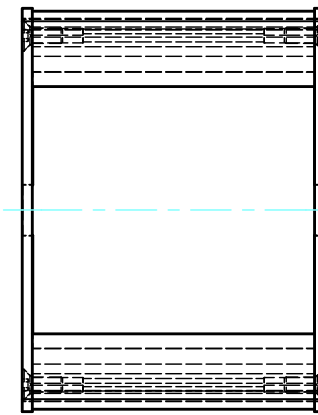

下カバー / Bottom cover

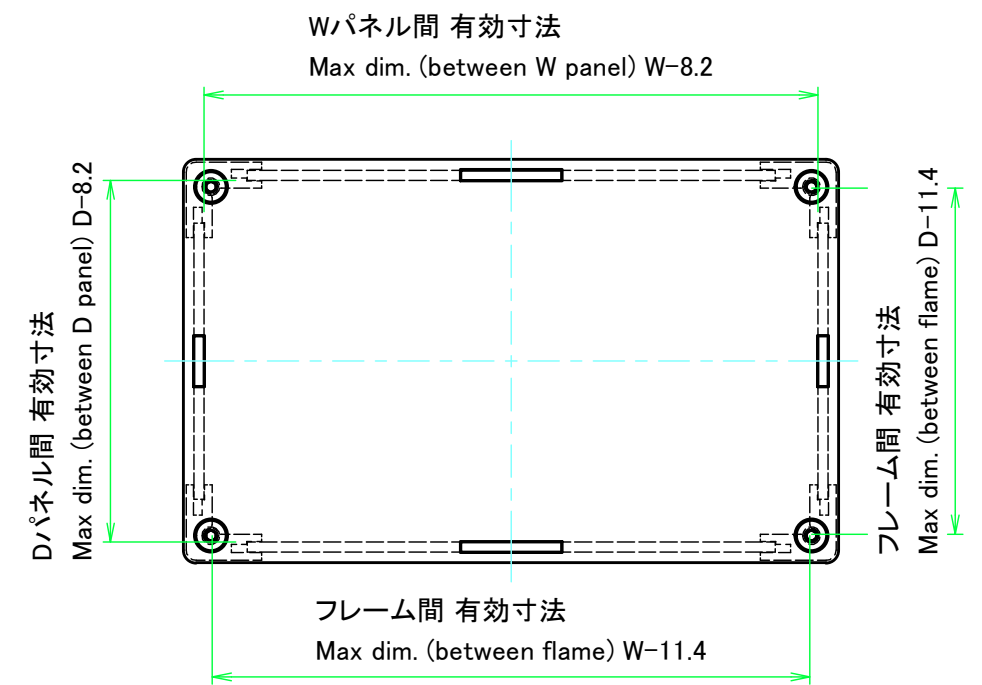

Wパネル1 / W Panel 1

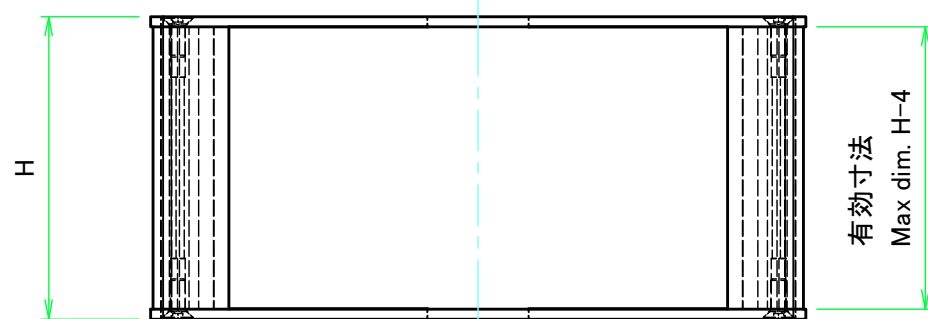

<b>株式会社タカチ電機工業</b> <small>TAKACHI ELECTRONICS ENCLOSURE CO., LTD.</small>			品名/Title 角型スケルトンフリーサイズケース CUSTOM SIZED ACRYLIC CASE	尺度/Scale 1:1.5
承認/Approved	検図/Checked	製図/Created	型番/Product number SKSF□-□-□K15□ (W101~150, D50~100)	
中根	野村	常山	作成日/Date 2020/11/20	2 / 5

上下カバー / Top and Bottom cover

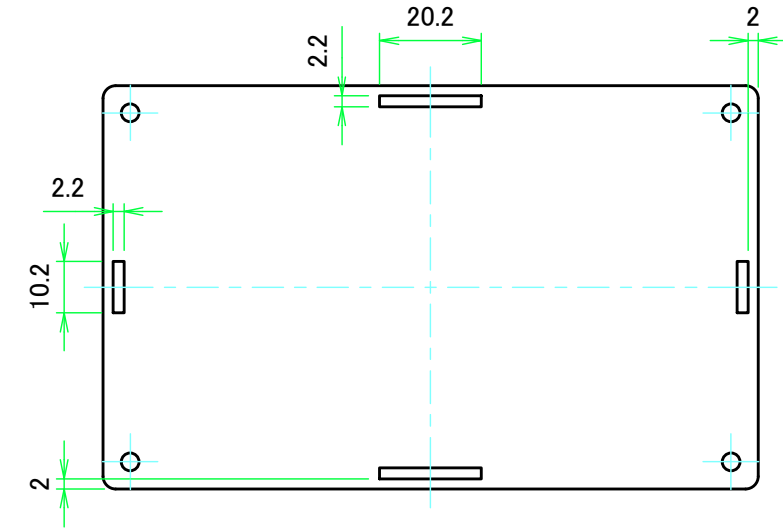
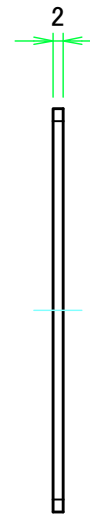
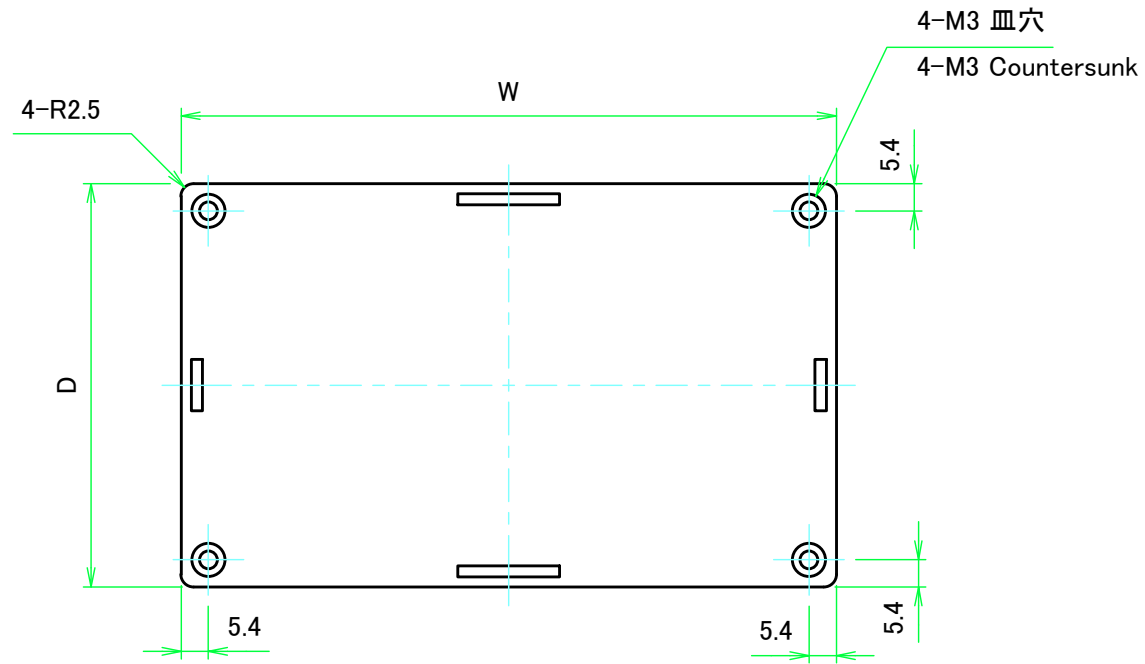

上カバー表面 / Top cover Frontside

上カバー裏面 / Top cover Backside

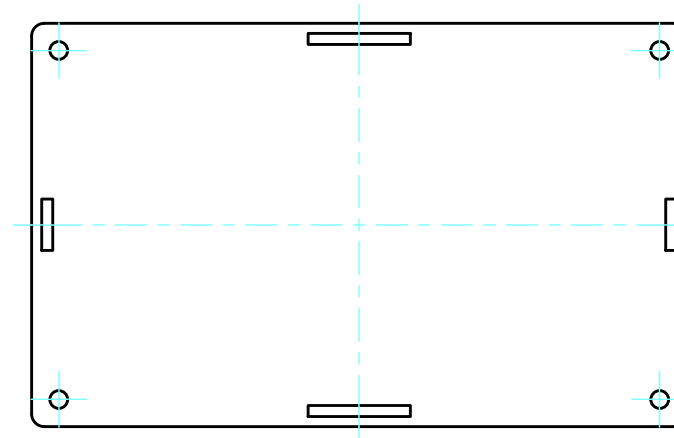
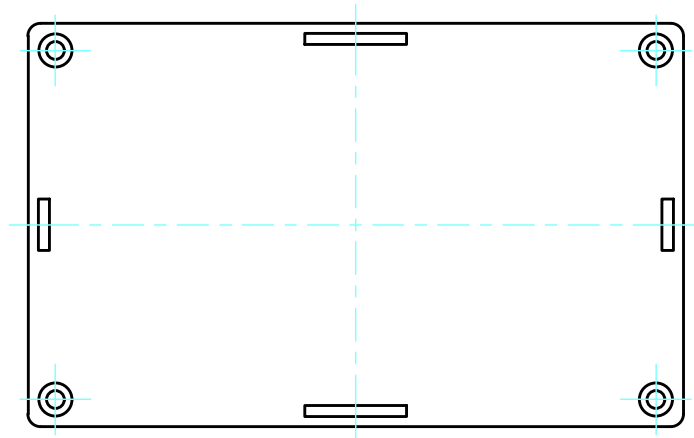

下カバー表面 / Bottom cover Frontside

下カバー裏面 / Bottom cover Backside

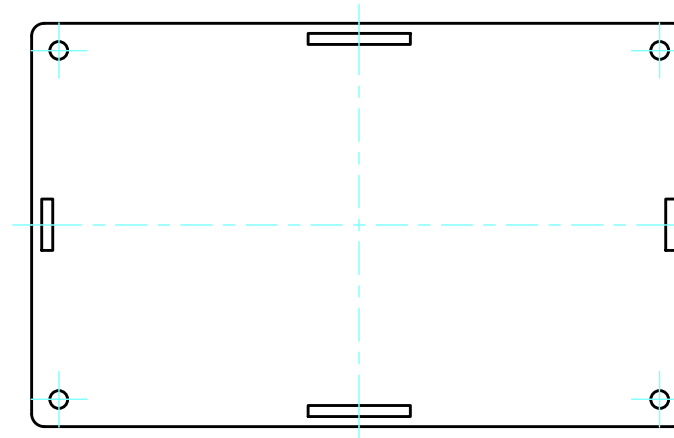
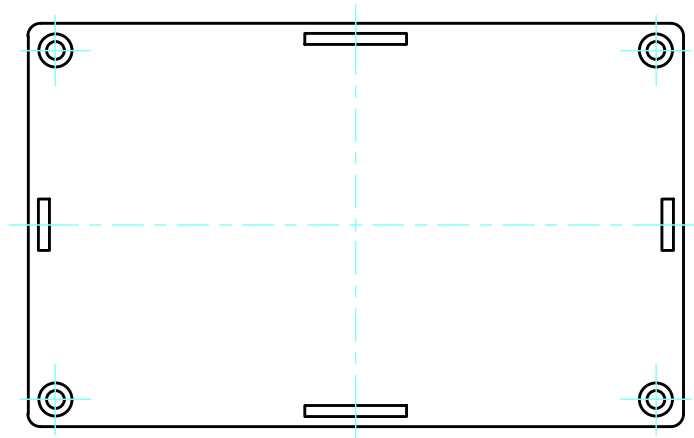

株式会社タカチ電機工業 TAKACHI ELECTRONICS ENCLOSURE CO., LTD.			品名/Title 角型スケルトンフリーサイズケース CUSTOM SIZED ACRYLIC CASE	尺度/Scale 1:1.5
承認/Approved	検図/Checked	製図/Created	型番/Product number SKSF□-□-□K15□ (W101~150, D50~100)	
中根	野村	常山	作成日/Date 2020/11/20	3 / 5

Wパネル / W Panel

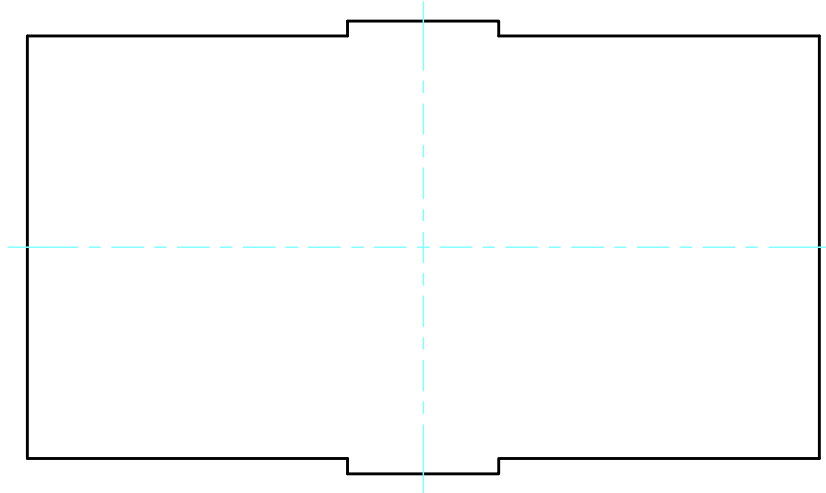
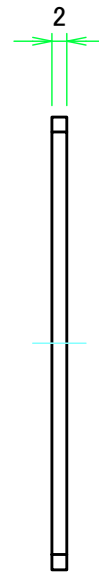
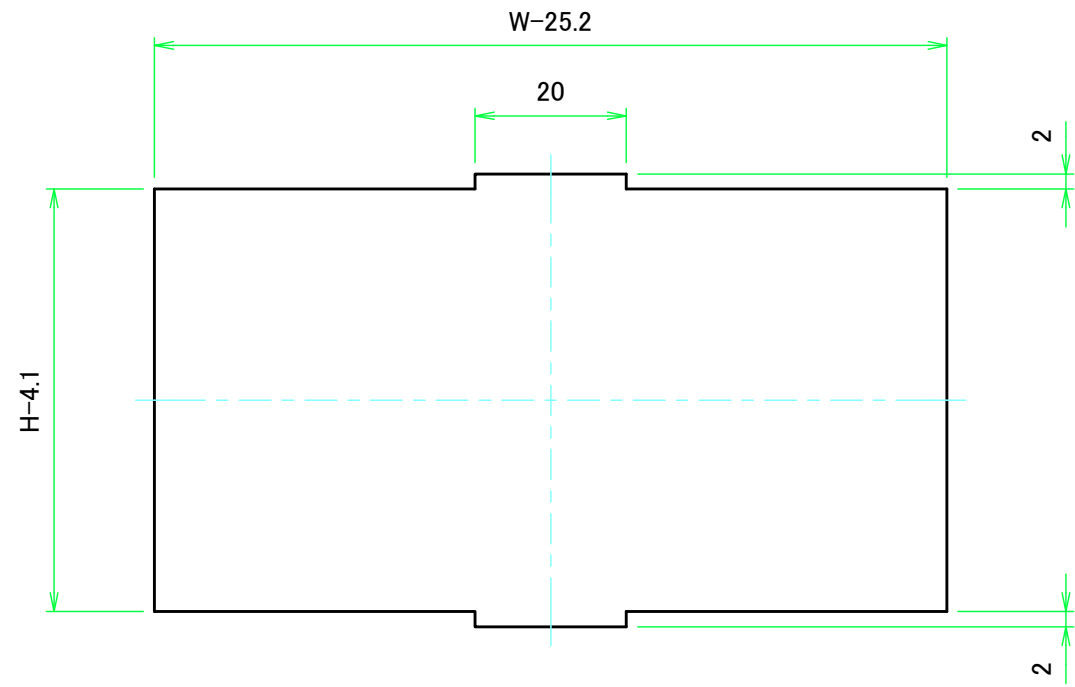

Wパネル1表面 / W Panel 1 Frontside

Wパネル1裏面 / W Panel 1 Backside

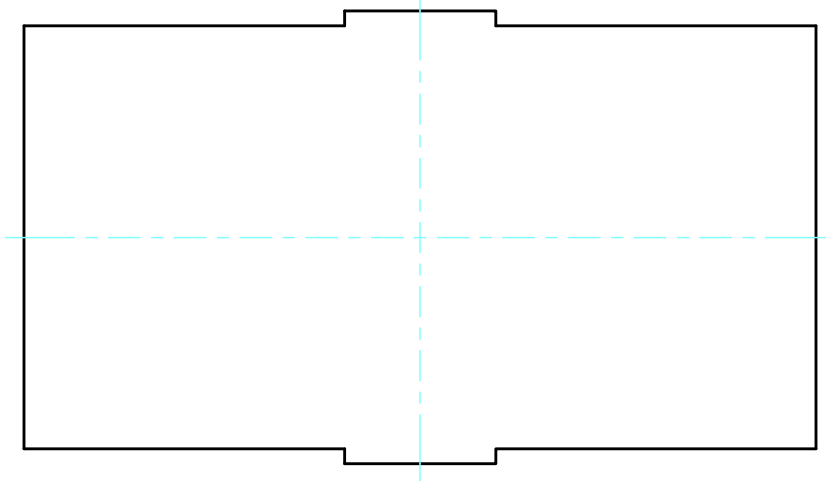
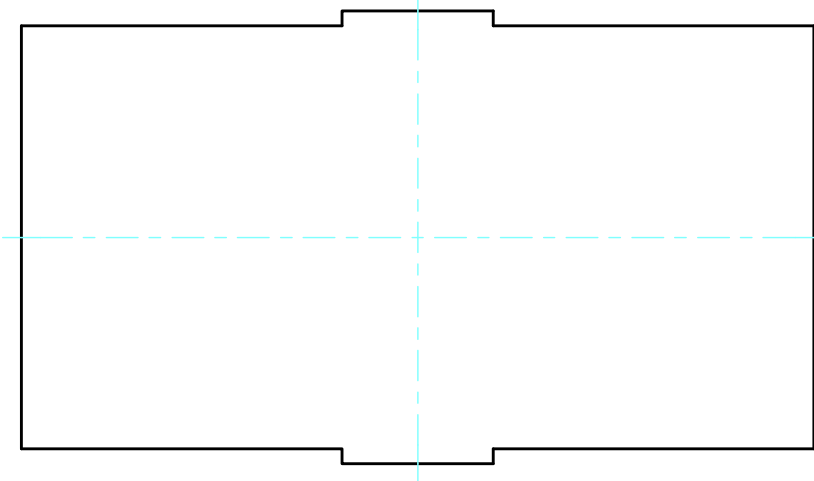

Wパネル2表面 / W Panel 2 Frontside

Wパネル2裏面 / W Panel 2 Backside

 株式会社タカチ電機工業 TAKACHI ELECTRONICS ENCLOSURE CO., LTD.			品名/Title 角型スケルトンフリーサイズケース CUSTOM SIZED ACRYLIC CASE	 尺度/Scale 1:1
承認/Approved	検図/Checked	製図/Created	型番/Product number SKSF□-□-□K15□ (W101~150, D50~100)	
中根	野村	常山	作成日/Date 2020/11/20	4 / 5

Dパネル / D Panel

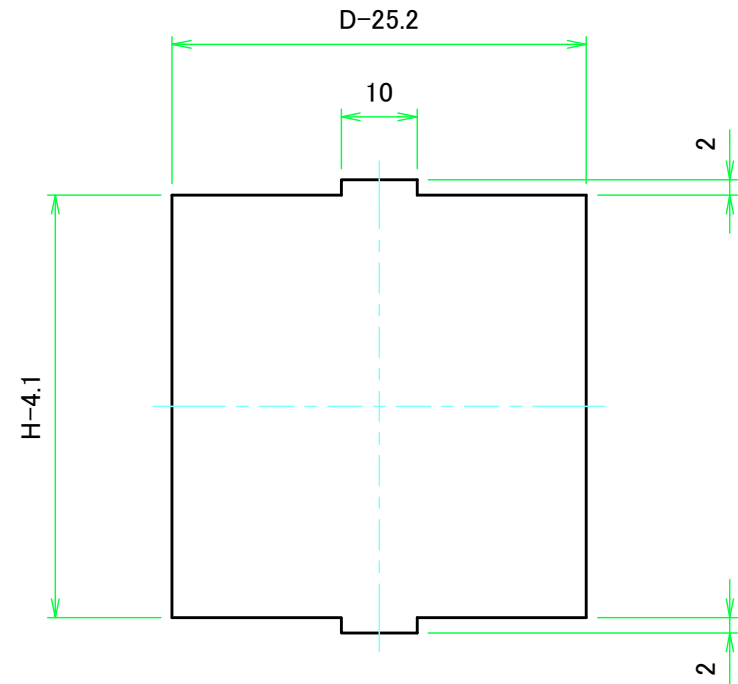

Dパネル1表面 / D Panel 1 Frontside

Dパネル1裏面 / D Panel 1 Backside

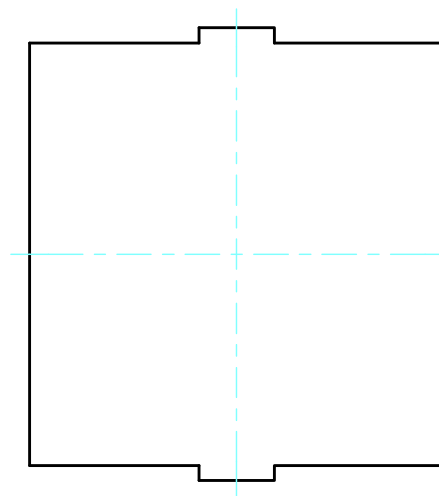
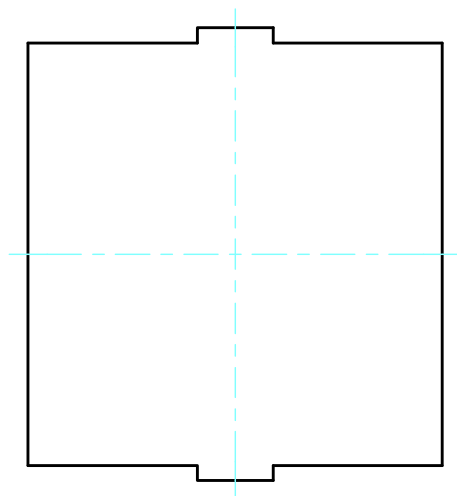

Dパネル2表面 / D Panel 2 Frontside

Dパネル2裏面 / D Panel 2 Backside



株式会社タカチ電機工業 TAKACHI ELECTRONICS ENCLOSURE CO., LTD.		品名/Title 角型スケルトンフリーサイズケース CUSTOM SIZED ACRYLIC CASE	尺度/Scale 1:1
承認/Approved	検図/Checked	製図/Created	
中根	野村	常山	作成日/Date 2020/11/20
			5 / 5